

Data Sheet



Article number: 03503020

Description: Fluro Rod end GE 20HO-2RS

Measures

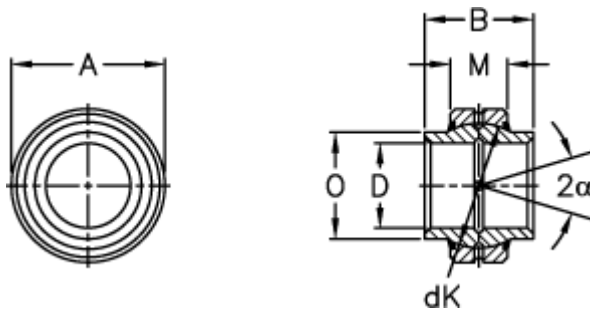

A	= 35 0 -0,011	Tilt angle = 3
B	= 24	Weight = 69
D	= 20 0 -0,010	
dK	= 29	
Dynamic load C (kN)	= 30	
M	= 12	
O	= 24	
Static load C0 (kN)	= 146	